



## 581-484F 8' MODERN BIPOD ADA SWING Installation Guide



**SportsPlay**<sup>TM</sup>  
We Put the Value in Play!

### **INSTALLATION INSTRUCTIONS**

**581-484F**

**8' MODERN BIPOD ADA SWING**

**Please read the entire manual before beginning installation.**

1 CTN	8 PIPE	3 WF	12 TOTAL PCS	200# WEIGHT	CLASS 70
-------	--------	------	--------------	-------------	----------



## **TAB SECTION INDEX**

1. 3D AND 2D DRAWINGS
2. INSTALLATION GUIDE
3. INSTALLATION STEPS
4. COMPONENT INSTALLATION
5. APPENDIX
6. ORIGINAL COMPONENT MAINTENANCE FORMS
7. COMPLETED COMPONENT MAINTENANCE FORMS



# 581-484F 8' MODERN BIPOD ADA SWING Installation Guide

## Table of Contents

3D DRAWING .....	
TOP DOWN VIEW .....	
FOOTING VIEW .....	
Important.....	6
When you receive your playground .....	6
Before you begin.....	6
Safety Surfacing .....	8
Tools and Materials.....	9
BEFORE BEGINNING .....	10
SITE REQUIREMENTS .....	10
MAINTENANCE: .....	10
PLAY AREA:.....	10
Installation Punch List .....	
Footing Layout Example.....	
Step 1: Layout.....	11
Step 2: Holes .....	11
Step 3: Deck, Post & Component Installation .....	12
Step 4: Concrete .....	12
Step 5: Last Step .....	12
Four Hole Bracket & Panel Bracket Installation .....	
Other Installation Tips .....	13
SUPERVISION GUIDE .....	14

## HARDWARE DRAWINGS

## COMPONENT INSTALLATION INSTRUCTION SETS

## APPENDIX

### FINAL INSTALLATION STEPS

### MAINTENANCE AND INSPECTION



## 581-484F 8' MODERN BIPOD ADA SWING Installation Guide

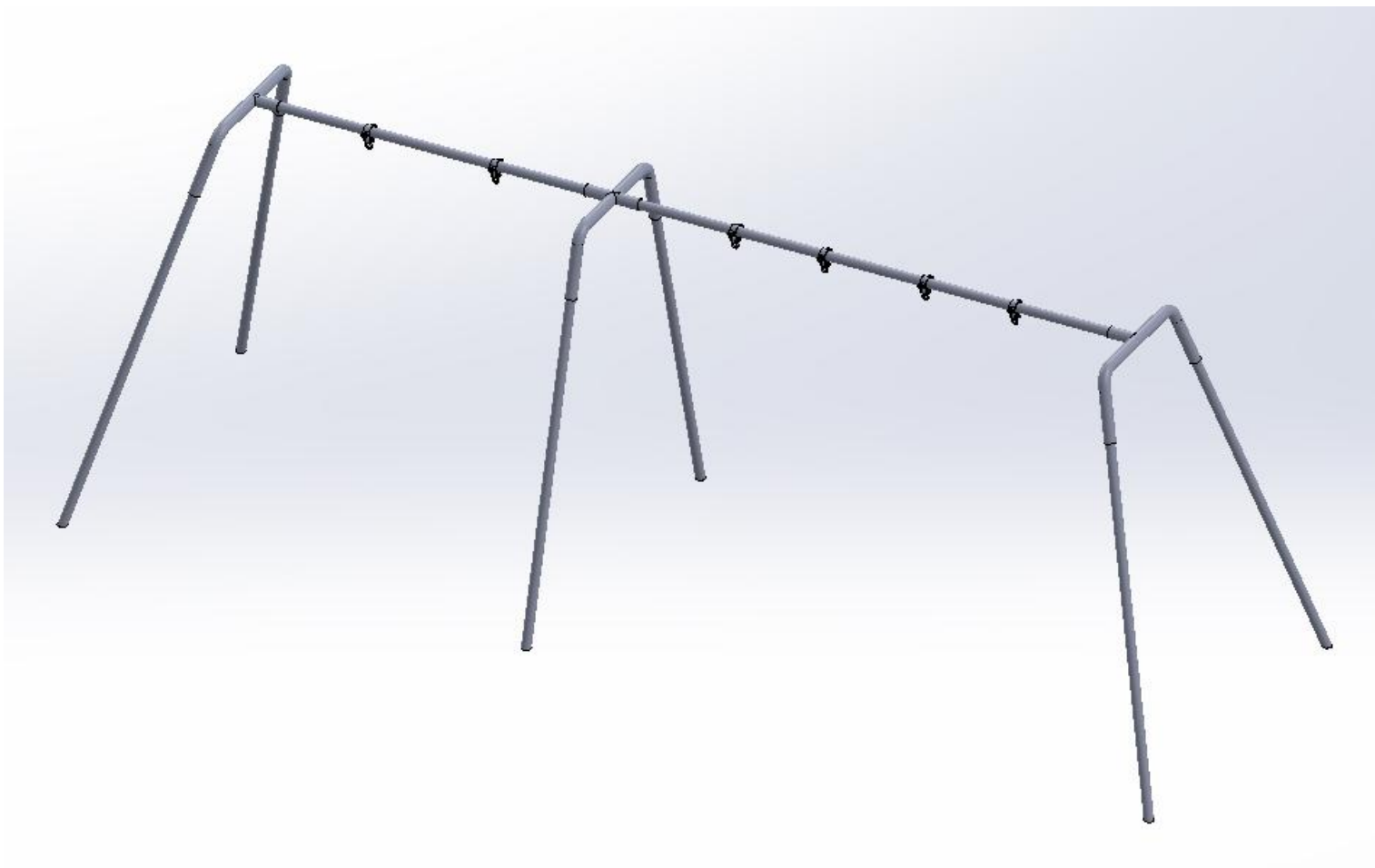



# 581-484F 8' MODERN BIPOD ADA SWING Installation Guide

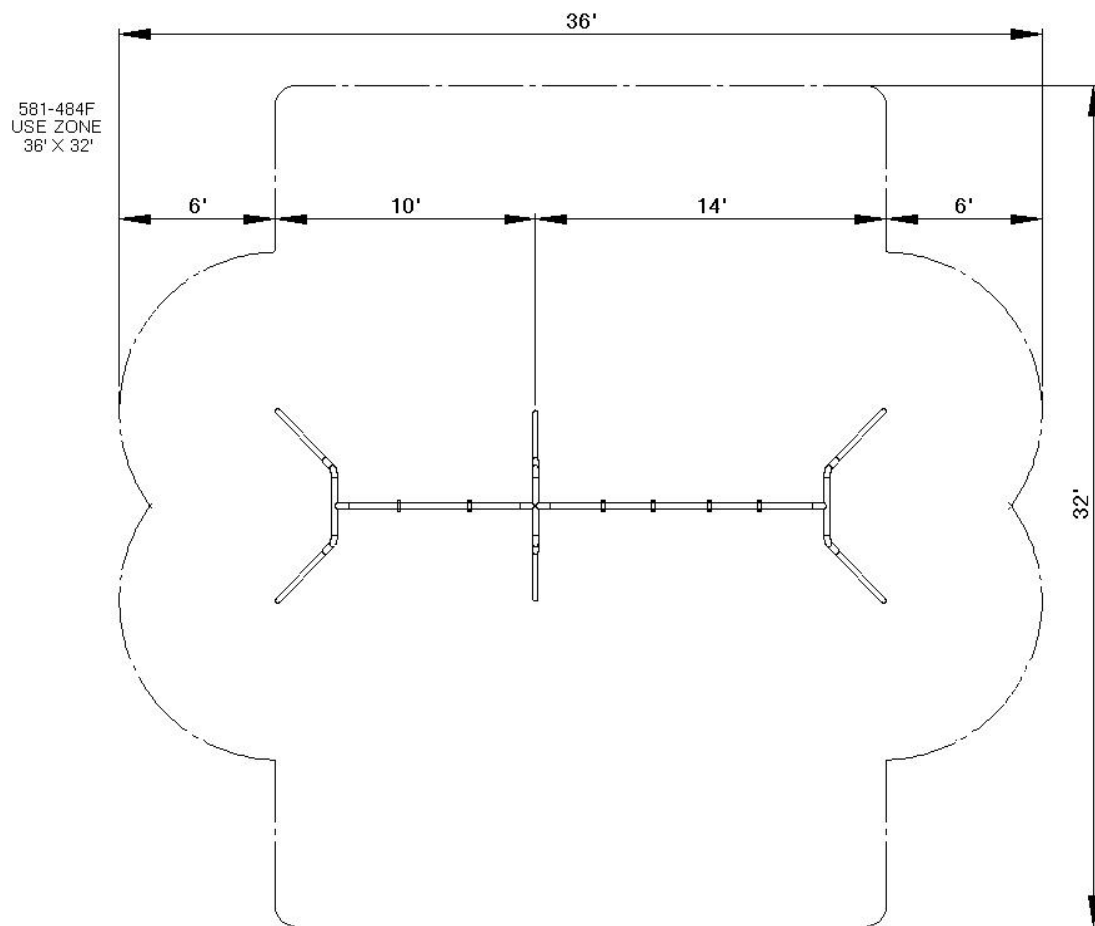



# 581-484F 8' MODERN BIPOD ADA SWING Installation Guide

## **Important**

### **Please read completely before beginning installation.**

This equipment has been designed for safety as well as challenge and fun. This equipment has been designed to reduce injuries and therefore must be installed “Step by Step” per our Instructions.

The U.S. Consumer Product Safety Commission (CPSC) published a report stating 79% of all playground injuries treated in U.S. Emergency Rooms was the result of a fall. It is critical that you refer to the Protective Surfacing section of these instructions, located on the next page prior to installing your playground. As the owner you are responsible for the safe installation of not only the play equipment, but also the safety of the site.

### **When your receive your playground**

- Identify all parts by comparing them to the part list and component instruction pages.
- Always compare the number of pallets, cartons or other items the BOL has listed with the number actually received. Note the any discrepancies on the BOL.
- Also note any obvious damage to the packing materials, pallets or components on the BOL.
- Equipment should be inventoried and installed within a few days of receipt. The packing materials are meant to protect the equipment during shipping and not for storage. Heat, weather and sunlight can damage the packing materials, which can impact the components. If storage is required you must store the equipment in a controlled environment away from heat, moisture and sunlight. SportsPlay recommends carefully unpacking the unit and taking an inventory before

storing the equipment. Care should be taken with all powder coated and thermoplastic-coated parts to prevent damage to the coating.

- You have 30 days from receipt of your equipment to file a claim for missing or damaged parts.

### **Before you begin**

Review your playground footing and top view drawings to ensure your site is large enough. These guidelines are available from the CPSC (contact information for the CPSC is located on the next page).

- Read through the entire instruction booklet before beginning the actual installation.
- Before you begin preparing the site or digging any holes you must first contact your local utility companies so they can visit the site and mark all of the buried utilities. In the U.S. you may call 811 and your call will be routed to your local utility center.
- This equipment was designed to install on a clear and level site. There should be no more than 3” of grade variations in a 10’ span.
- Footing layout is the first critical step once the installation begins. Mark all holes using the footing diagram. Prior to digging holes compare the measurements from the footing diagram to the actual site markings to ensure accuracy. Then check it again! (Footing info is located on pg 16 in this guide)
- Our posts are manufactured to accommodate 12” of protective surfacing.
- Evaluate the site for drainage. To ensure good drainage around the equipment consult a local professional.
- Do not leave the jobsite un-attended during installation unless all access points to the play area are secure, all bolts and fasteners are tight and all ground holes are covered.



## 581-484F 8' MODERN BIPOD ADA SWING Installation Guide

---

- SportsPlay Equipment inc. has provided two warning labels that state: “WARNING – Installation over a hard surface such as concrete, asphalt or packed earth may result in serious injury or death from falls.” These labels must be installed on vertical posts as per ASTM F1487. Instructions for the placement of these labels are included in the appendix of this booklet.
- SportsPlay will provide manufacturer identification labels that must be installed on the structure during installation per ASTM F1487. Installation instructions for these labels are included in the appendix of this instruction manual.
- Labels must be replaced when they are no longer legible. Contact your distributor for replacement labels.



## 581-484F 8' MODERN BIPOD ADA SWING Installation Guide

### **Safety Surfacing**

**WARNING! – INSTALLATION OVER A HARD SURFACE SUCH AS CONCRETE, ASPHALT OR PACKED EARTH MAY RESULT IN SERIOUS INJURY OR DEATH FROM A FALL**

Because accidental falls are likely to occur around play equipment, SportsPlay Equipment Inc. recommends that a resilient safety surfacing that will meet standard ASTM F1292 be placed under and around the structure and extend throughout the entire use zone.

SportsPlay Equipment Inc. does not manufacture safety surfacing. All manufacturers of safety surfacing require different depths of surfacing for fall heights. Consult your surfacing supplier about the required safety surfacing depth for your play equipment.

**SportsPlay Equipment Inc. manufactures all playgrounds to accommodate 12” of safety surfacing. If you intend to adjust the height of the surfacing you will need to adjust the depth of the footing to accommodate the surfacing height.**

Refer to the CPSC Handbook for Public Playground Safety for the recommended type and depth of the protective surfacing as well as all other playground safety concerns.

For a copy of the most current issue of the CPSC Handbook for Public Playground Safety, write to:

**U.S. Consumer Product Safety Commission**  
Office of Information and Public Affairs  
Washington DC, 20207  
USA

Call - 1-800-638-2772 (US and Canada only)  
Call - 301-504-0990  
Direct Link - <http://www.cpsc.gov>

For a copy of either the standard for surfacing (ASTM F1292) or for play equipment (ASTM 1487) write to:

**American Society for Testing and Materials**  
100 Bar harbor drive  
West Conshohocken PA, 19428-2959  
USA

Call – 618-832-9585

Web Site – [www.astm.org](http://www.astm.org)

You must consider the type of safety surfacing you will use before beginning the installation process. There are two general types, organic/loose fill or synthetic unitary (pour in place). You must know which type of surfacing you are going to use prior to installing the playground. This unit was designed for 12” of loose fill surfacing so if the customer wants to use a synthetic unitary product that has a much smaller height than 12” you must dig the footing holes deeper to allow for the difference.

If loose fill surface material is to be used (example: wood mulch) you will need to consider containment borders. There are many products to choose from including hard plastic and natural products such as wood (Creosoted railroad ties are NOT recommended for use as borders in a play area). Loose fill materials are easily displaced so use of some type of containment border is necessary to keep the surfacing material inside the intended area. Some customers also prefer to have a weed mat installed to prevent weed growth. Choose a mat that will prevent growth but will also allow for drainage.





## 581-484F 8' MODERN BIPOD ADA SWING Installation Guide

---

### Tools and Materials

List is for tools and materials needed that are not included with the playground

Follow manufacturer's guidelines for proper use of tools and materials.

- The best method (also the easiest) to dig the postholes is using a tractor with a 12" auger attachment.
- Shovels (long handled spades)
- Post hole digger
- Wheelbarrow
- Large construction bar (5')
- Claw hammer
- Large dead-blow rubber hammer
- Small sledgehammer to use in blocking the posts
- Strong and sturdy step ladders
- Extension cords & power supply
- Levels – Magnetic torpedo and 4' long levels
- Scrap lumber to use for shims in post holes to keep posts level
- Blocking materials for the post holes (bricks, concrete blocks, etc.)
- Files and sand paper
- Safety surfacing
- Spray paint to mark holes
- String line
- Cement (2,500 psi minimum)
- Straight line or transit level (and tripod) for ensuring hole depths are at the same level



## 581-484F 8' MODERN BIPOD ADA SWING Installation Guide

**BEFORE STARTING INSTALLATION OF YOUR PLAYGROUND,  
PLEASE READ INSTRUCTIONS THOROUGHLY.**

### **BEFORE BEGINNING**

#### **SITE REQUIREMENTS**

The Playground system is designed to suit a level site. Should there be any falls or slopes on the site; care should be taken to accommodate the entry and exit points and to maintain the correct height. There should not be more than 3" of drop in grade per every 10'.

The site must be inspected for natural obstacles such as roots or rocks that may be a trip hazard, poor drainage and sharp objects such as glass.

Every state has different rules and regulations governing digging, some are stricter than others. In addition, 62 separate One Call Centers serve different areas of the country; now 811 will connect you directly to your local One Call Center. Prior to digging, be sure to call 811 or the local One Call Center to prevent accidentally disrupting local utility service.

#### **MAINTENANCE:**

As an owner, it is most important that you are aware of your responsibility to insure safe use of your new equipment. It is necessary to install equipment according to the installation instructions provided and inspect the equipment at regular intervals. During inspection, if any part is found damaged or excessively worn, equipment should be closed immediately. A maintenance section is included in the appendix of this instruction booklet.

If a part is missing or damaged the playground must be put out of service while the part is replaced. Lack of maintenance will result in premature wear, reduced life expectancy, and possible failure that may result in injury.

All SportsPlay Equipment play events have been engineered to meet all applicable safety guidelines, but if installed improperly, these problems may occur:

- Entrapment gaps (between 3 1/2" and 9")
- String Entanglements
- Protrusions

Make sure that any bolt end that protrudes more than 2 threads past the face of the nut is trimmed and de-burred smoothly. Always double-check your work.

Installation must adhere to the manufacturer's assembly manual and all other applicable safety guidelines.

#### **PLAY AREA:**

The area immediately above and around the play structure must be free of any obstructions such as:

- Trees
- Other Play Equipment
- Buildings
- Overhead Power lines

**Make sure the play area has all the required safety surfacing and the minimum fall zones as required by the safety guidelines. These guidelines can be found at [www.cpsc.gov](http://www.cpsc.gov).**

**CHILDREN MUST BE SUPERVISED AT ALL TIMES. No playground is safe without adult supervision!**

There may be situations that require you to modify the layout or use your own judgment. If you have any questions contact your distributor.

Reading this entire manual before beginning the installation will help you to ensure your equipment is installed and maintained correctly.

## Step 1: Layout

1. Lay structure in the desired location using the top view layout drawing. Measure from each post to ensure there is adequate space for any component and the components fall zone. This drawing is a standard drawing and does not represent the actual playground you are installing.
2. Most installers like to orientate the playground so that the entry point of the playground is facing either the sidewalk or the direction from which the children are entering the play area.

## Step 2: Holes

1. If the site grade is not level you have to adjust the footing depth to maintain a level footing. Check with building codes to ensure you meet required hole depth and width. If a deeper footing is required you must add blocking materials to the hole to keep the post depth in accordance with the footing side view drawing on the next page.
2. Once the structure is in the desired location within the play area, mark the locations of the post by inserting a stake into the center of each post location (see drawing below for an example). If using spray paint to mark location please be careful not to spray the post.
3. Match the post location marks with the footing layout in the front of this booklet. Dig your holes using the main post footing drawing below. If your surface grade is not level you should start with the lowest point and use that hole depth to level all other holes too. The footing drawing below indicates a depth of 22" plus the thickness of a brick (or the thickness of whatever blocking material you will use instead of a brick). This depth is for 12" of surfacing only. If you are using something other than 12" of surfacing, such as 3" of rubber your hole depth would have to be 31" plus the thickness of a brick to allow for less surfacing material.

## FOOTING SIDE VIEW



4. It is recommended that you use a transit to level the remaining post holes to the first hole in order to ensure that the posts are level.



## 581-484F 8' MODERN BIPOD ADA SWING Installation Guide

---

### Step 3: Post & Component Installation

1. We recommend installing the posts once the post are square and level you may add the concrete (concrete with a minimum of 2,500 psi should be used). Mix concrete per manufacturers instructions and let it cure for at least 24 hours before continuing.
2. **NEVER LEAVE THE INSTALLATION SITE UNATTENDED WITHOUT ROPING OFF THE AREA AND EQUIPMENT, INSTALLING ALL HARDWARE, SECURING TOOLS AND EQUIPMENT, AND COVERING OPEN HOLES WITH A RIGID MATERIAL (PLYWOOD). CHILDREN WILL TRY TO USE THE EQUIPMENT EVEN THOUGH ITS NOT FULLY ASSEMBLED. YOU MUST TAKE ACTION TO PREVENT INJURY AND DAMAGE.**

### Step 4: Concrete

1. Verify all swing posts and fittings are tight, level and square. Once the unit is verified to be level and square you may start installing concrete. You must use concrete with a minimum of 2,500 psi.
2. Always pre mix the concrete to the manufactures directions before pouring it into the hole. Never put dry concrete in the hole. Typically each main posthole requires two 80-pound bags of concrete.
3. Allow concrete to set in accordance with manufacturers directions. Fill holes too about 2" below the surface with concrete. Once the hole has been filled with concrete, slope the top of the concrete down and away from the post to keep water from seeping between the post and the concrete.
4. Secure playground area to prevent access while the concrete is setting for a minimum of 48 hours.

5. SportsPlay recommends having a CPSI (certified playground safety inspector) present during installation. If that's not possible you should have the completed playground (after surfacing is in place) inspected by a CPSI.

### Step 5: Last Step

1. After concrete has completely set, backfill all holes with dirt.
2. Install surfacing.



## 581-484F 8' MODERN BIPOD ADA SWING Installation Guide

---

### Other Installation Tips

- **If you are mocking up components with the intention of removing the hardware at some point**, you may want to apply lubricating oil to the hardware. Stainless steel hardware has a tendency to seize so if you are planning on removing the hardware you may want to apply lubricant to prevent this.
- Unless specified in the specific component instruction step, **do not tighten the hardware completely** until the entire unit is assembled.



## 581-484F 8' MODERN BIPOD ADA SWING Installation Guide

---

### **SUPERVISION GUIDE**

Although the equipment is designed, installed and maintained in accordance with all safety guidelines adult supervision is required.

Not all equipment is appropriate for all ages. Direct children to age appropriate equipment.

Younger children will require more supervision than older children.

While eliminating accidents is not likely, following these guidelines will help minimize accidents.

Basic playground safety for supervisors:

- Make sure all safety surfacing is in place and at the correct height. Inspect area for hard or sharp objects and remove them.
- No dangerous horseplay in the play area. (Jumping from dangerous heights, displacing of surfacing, etc...)
- Inspecting for missing or broken equipment. (Do not allow children to play on broken equipment or equipment with missing components).
- Make sure there are no unsafe modifications (especially ropes tied to equipment). Remove all unsafe modifications and close the equipment for play until they are removed.
- Keep children in the designated play area.
- Do not let children play on wet equipment.
- Prevent overcrowding on play equipment.

- Loose clothing, hoods, strings or jewelry shall be tight or not worn while playing to prevent strangulation.
- Ensure the temperature of the equipment is not hazardous. Direct sunlight exposure can increase the temperature of the equipment high enough to cause injury.
- Inspect the playground every day using the General Inspection Checklist located in the appendix of this manual

The easiest method for performing the daily inspection with the checklist is to laminate the checklist and use a dry erase marker to mark the items off before opening the play area



3/16 ALLEN WRENCH (YELLOW BAG)

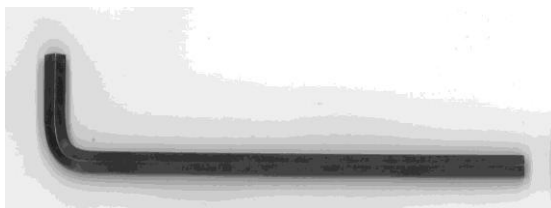

1/4 ALLEN WRENCH (BLUE BAG)



5/16 WRENCH (RED BAG)

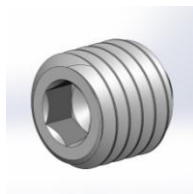

1/2 X 1/2 SET  
SCREW

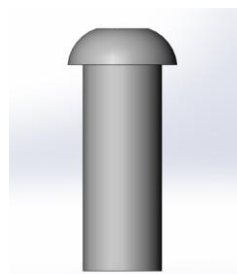

5/16 X 1 BUTTON  
HEAD NUT

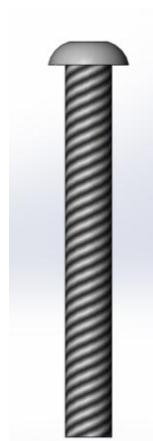

5/16 X 2 1/2 BUTTO..  
HEAD BOLT

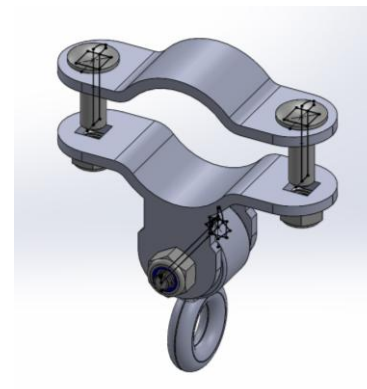

2 3/8" SWING  
HANGER

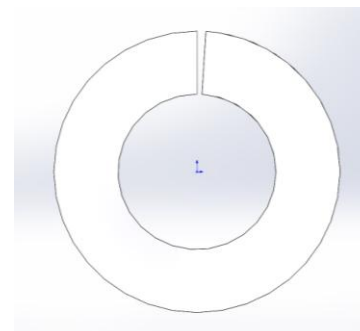

5/16 LOCK  
WASHER



# **COMPONENT INSTALLATION INSTRUCTIONS**



#### **INSTALLATION DETAILS**

- Recommended crew (Adult): 2
- Installation time: **4 hr**
- User age: **5-12**
- Use zone: **32' x 36'**
- Weight: **200 lbs**

**SURFACING: Use of safety surfacing in compliance with ASTM specification F1292 is required.**

#### **MAINTENANCE:**

- As the owner of the playground you are responsible for maintenance of the equipment and play area. A maintenance schedule must be developed and the equipment inspected frequently. A maintenance section that includes component specific maintenance requirements is included at the end of this manual.
- Be sure to inspect surfacing for foreign objects that could cause injury and that sufficient surfacing are in place in accordance with ASTM and CPSC standards.

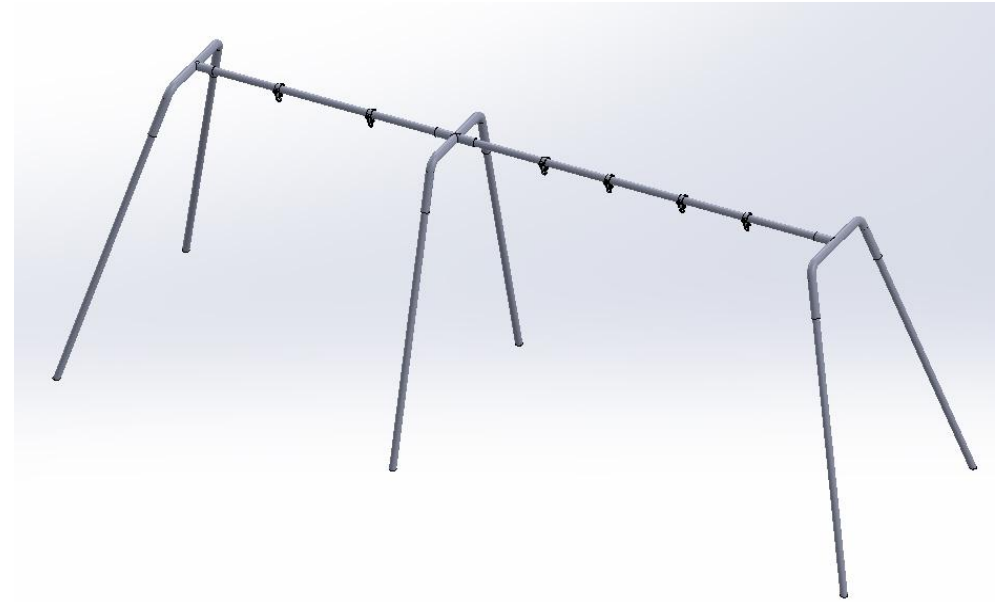

**PARTS LIST**

ID	PART #	DESCRIPTION	QTY
1	583-522	Swing End	2
2	583-523	Center Fitting	1
3	343-210A	2 3/8" x 11' Pipe	7
4	523-603	2 3/8" x 7'6" Pipe	1
5	585-520	2 3/8" Swing Hanger	6
6	196-802	1/2" x 1/2" Socket Set Screw	10
7	116-545	5/16" x 2 1/2" Button Head Bolt	4
8	216-512	5/16" x 1" Button Head Nut	4
9	326-501	5/16" Lock Washer	4
10	416-350	3/16" Socket Key	2
11	416-400	1/4" Socket Key	2
12	416-500BPK	5/16" Socket Key	1
13	805-532	Warning Label	1
14	805-534	SportsPlay Label	1
15	516-400	Loctite	1

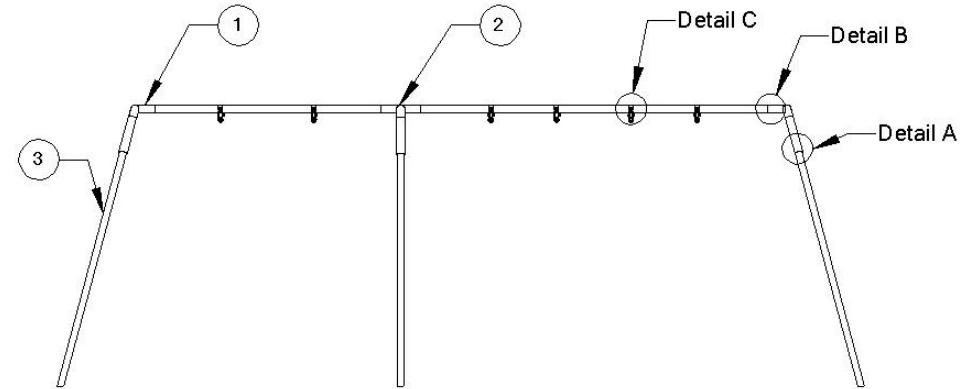

**NOTE:** Keep a copy of these instructions on file to assist you with maintenance and replacement parts.

### FOOTING INFORMATION

- Total footing depth is 24" less the height of the surfacing plus the height of the blocking material. If you are using 12" of surfacing the footing hole would need to be 12" plus the height of the blocking material (refer to both the side and front cutaway views to the right).
- If the Play structure is installed on an unlevel grade you must adjust the footing depth to accommodate the grade. For instance, if the grade for this component is 1" higher than the surface grade of the main playground post you must dig your footing hole 1" deeper.
- You must place the bottom of the support post or slide leg on a suitable flat blocking material to prevent it from sinking further into the soil. We recommend you use a brick, block of wood or several inches of gravel. The footing depth does not include this blocking material since materials used often vary.
- It is the owner/installers responsibility to check local building codes and to comply with those codes. All footing depths listed here are recommendations and local soil types and frost lines may require a deeper and/or wider footing depth. If that's the case you must add more blocking material to accommodate the deeper footing, as the post length will still only be installed at the depth listed in this instruction manual.
- Assemble the entire unit before adding the concrete unless instructed to do so in the individual component instruction sections.

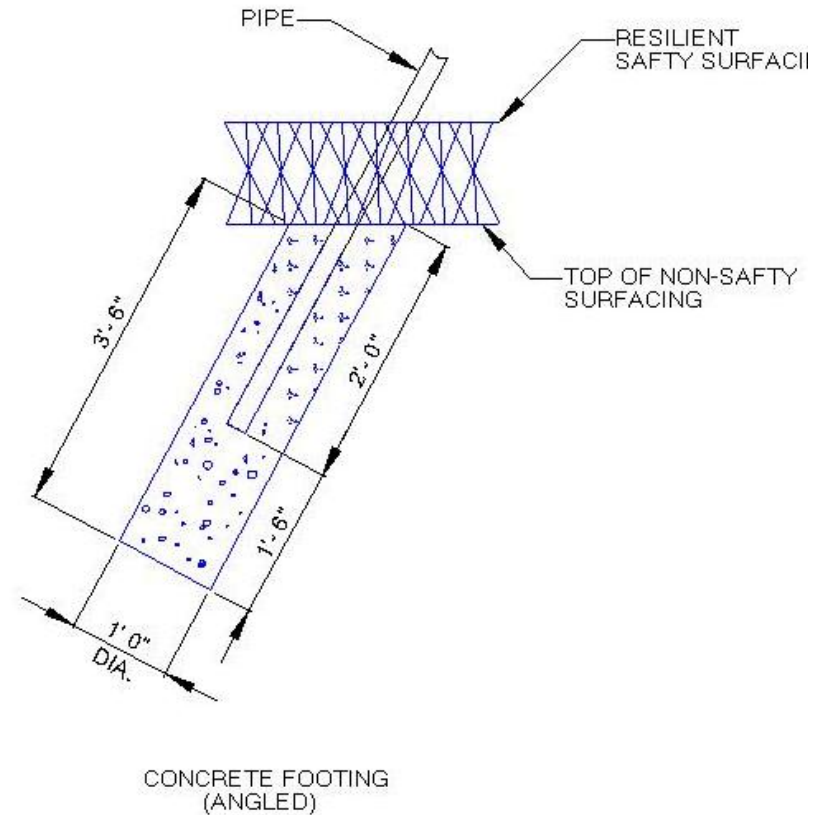

**ELEVATION AND  
FOOTING LAYOUT VIEW**

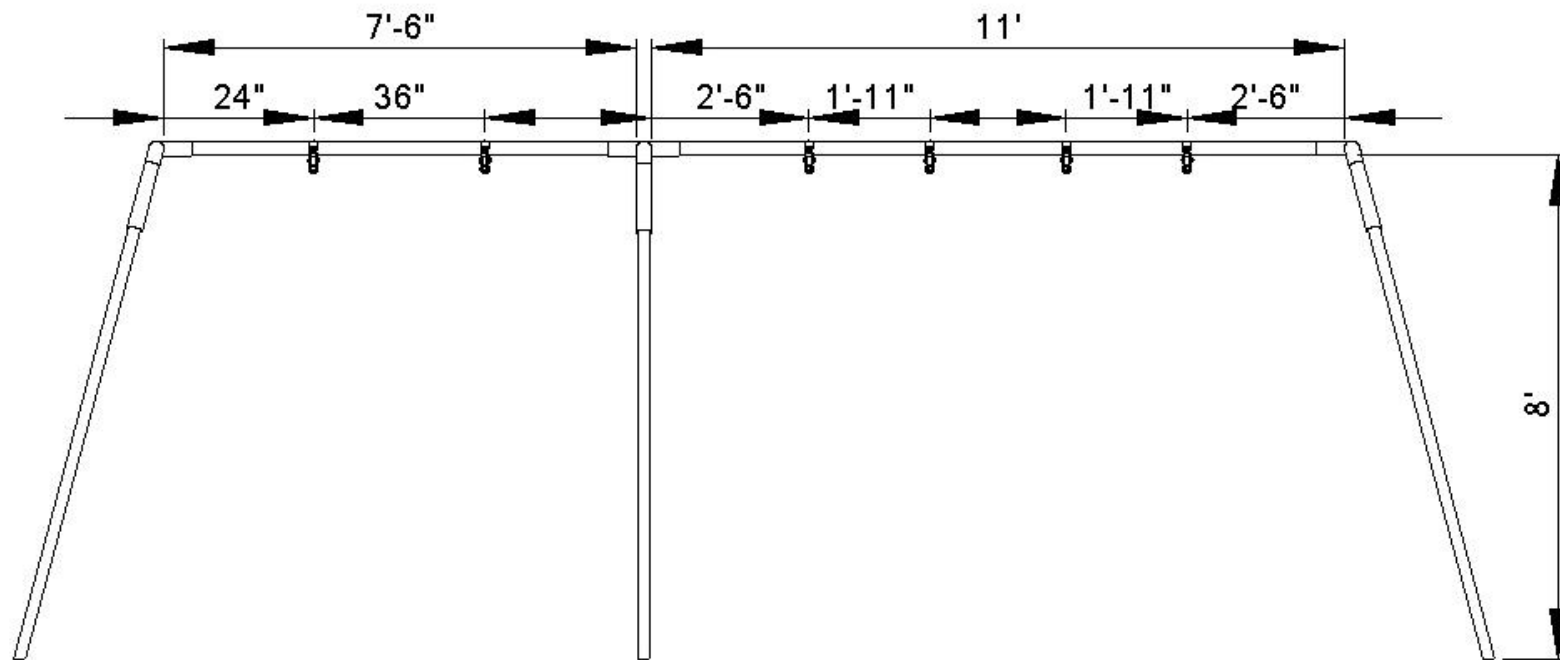



### **SPECIFICATIONS**

- **Tube** – FloCoat® Galvanized 2 3/8” O.D. and 2 7/8” O.D.
- **Hardware** – Stainless steel & tamper resistant

### **SPECIAL SAFETY & ASTM COMPLIANCE NOTES**

### **INSTALLATION TIPS & TROUBLE SHOOTING**

- Apply locktite to all bolts during assembly prior to completely tightening them.
- Stainless Steel hardware can occasionally be difficult to use particularly if you need to take them out to make an adjustment. It is recommended that you add a drop of oil to bolts that may have to be removed before you install them.
- Do not tighten bolts all the way until the unit is completely assembled and all components are square and level.
- Identify and separate all parts by referencing the detail drawings and the parts list.
- As you unpack and separate the components use the cardboard sheets that were used for packing and shipping to prevent damage to the components. This is particularly true all Powder Coated and Thermoplastic coated components, by setting the components on top of the cardboard.

### **BEFORE YOU BEGIN**

In addition to the components on the packing list you will need a tape measure, post hole digger, level and a dry erase marker.

### **INSTALLATION STEPS**

\_\_1) **Review all instructions before beginning:**

\_\_2) **Unpack, organize, and identify all components:** Be sure to place all painted components on a protective surface (cardboard, cloth, etc...) to prevent damage.

\_\_3) **Assemble Swing Frame:** Layout parts so that when frame is erected, legs will be in approximately correct position. Assemble swing frame on side, on ground. If more than one section, assemble section by section.

\_\_4) **Attach Swing End to Legs:** To do this you will need four 2 3/8" x 11' pipe (3), two swing end fittings (1). Place the swing legs into the swing end fittings tighten set screw. See (Detail A)

\_\_5) **Attaching Middle Post to Swing End:** You will need one 2 3/8" x 11' pipe (3), two 5/16" x 2 1/2" button head bolts (7), two 5/16 x 1" button head nut (8), two 5/16" lock washer (9). Slide the pipe into the swing end fitting until bottoms out and mark the top and bottom holes. With a small drill bit drill the marked spots then with a 7/16" drill bit drill the small holes bigger. Now secure it with bolt, lock washer and the button head nut. See (Detail B).

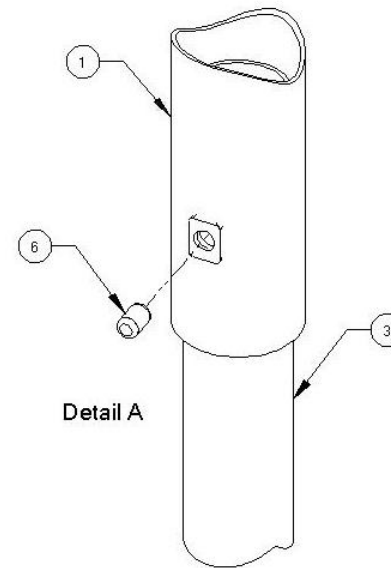

**INSTALLATION STEPS CONTIUDE**

\_\_6) **Attaching Swing Hangers:** You will need eight swing hangers (5), attach the swing hangers to the top rail following spacing on page 4. See (Detail C).

\_\_7) **Dig footing holes:** Footing holes may be marked out and dug from footing layout; however, it is easier to position swing in proper location, mark holes, move swing aside, and dig holes.

\_\_8) Stand swing upright onto legs and brace in footing holes so that 2' – 3' of pipe will be under intended level of resilient surfacing and the top rail is at desired height. Plumb and level entire unit. Tighten all set screws.

\_\_9) Once the entire playground has been installed and you have verified that the entire playground is level you can **add the concrete to the footing holes**. Be sure to use concrete with a minimum 2,500 psi and mix the concrete per the manufacturer's directions before you pour it into the footing hole. Once the footing has been filled with concrete you should rope of the area for a minimum of 48 hours to allow the concrete set properly.

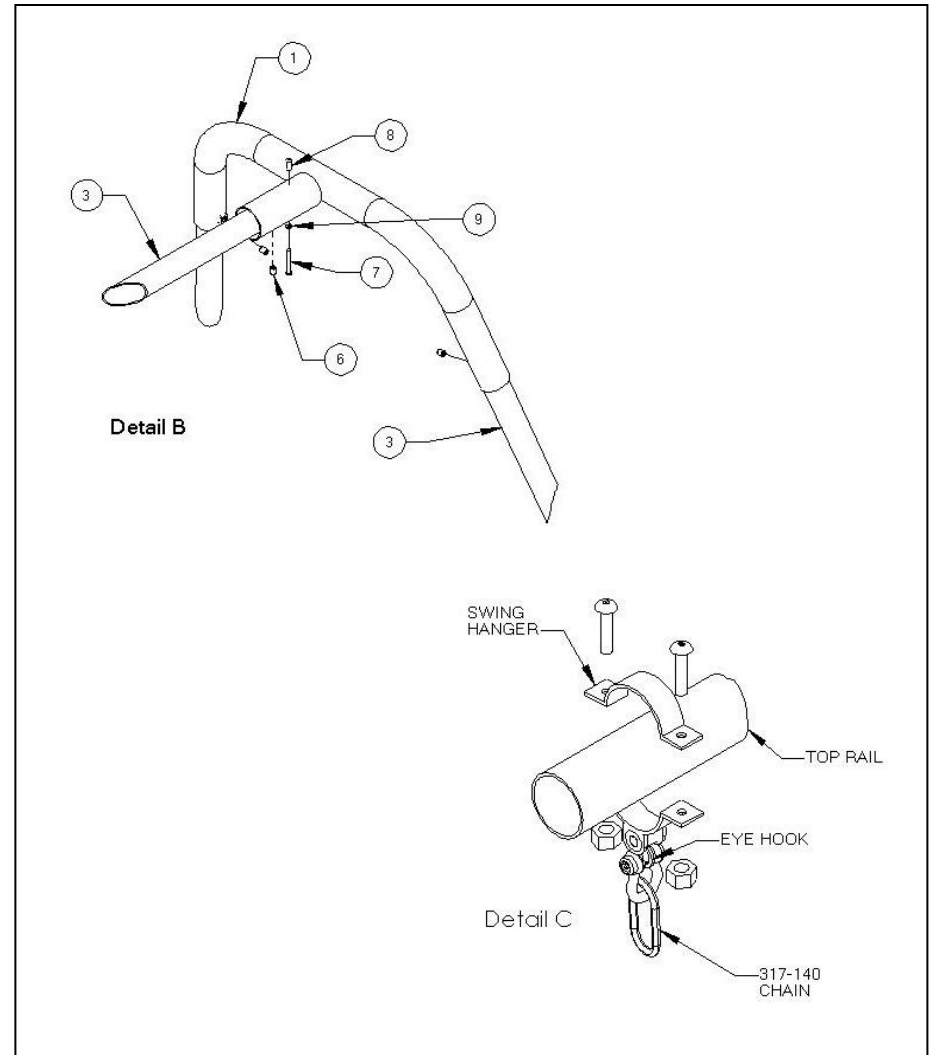



**INSTALLATION STEPS CONTINUED**

\_\_10) **Once the concrete has set**, back fill dirt over the footing holes; inspect the area and components for tools, hazardous debris and sharp edges. Verify all components are installed and all hardware is tight and then install the safety surfacing.

\_\_11) **Inspect the components:** for sharp edges and if necessary file them down and apply touch up paint.

